

Z-SERVER 19" SERVER CABINETS

DESCRIPTION

CABINETS FOR DATA CENTERS

STURDY DESIGN

- Strong bolted frame made of steel closed profiles.
- Maximum load capacity:
1500 kg for cabinet based on levelling feet,
1750 kg for cabinet without feet,
based directly on the floor.

MULTIPURPOSE

- Smooth tool-free adjustment of 19" mounting profiles.
- Mounting profiles are U-marked to simplify installation.
- The width can be changed from 19" to 21" with no need to use additional mounting elements (in 800 mm wide cabinets).
- Door opening angle up to 270 degrees, adjustable direction of opening.
- Easy installation thanks to split side panels.
- Optional mounting of partition panels between cabinets at any time of their operation.
- Tool-free mounting of the top plate of cabinet.
- The frame includes holes for mounting accessories.

SAFETY

- Multi-point cabinet locking system:
5-point locking system in single-leaf doors;
3-point locking system in double-leaf doors (5-point locking system as an option if adapting set is used).
- Locks with access control are available.

PERFORMANCE

- Doors with optimum perforation clearance of 80%.
- Up to 86% of the door area is perforated to provide adequate cooling for the installed devices.
- To optimise the flow of cold air we provide the following components to isolate cold and hot areas at the cabinet and Z-SERVER BOX server room.

Z-SERVER SYSTEM

The new Z-SERVER cabinet system represents innovative quality solutions for data-processing centres.

Scalable functionality and easy adaptation enabled by the available additional equipment:

- **Z-SERVER BOX cold aisle installation,**
- **air flow guiding elements within a single cabinet,**
- **logical cabling arrangement elements,**
- **power supply system mounting elements.**

REFERENCE CHART

Width W [mm]	Depth D [mm]	Reference number		
600	1000	426010	456010	476010
	1200	426012	456012	476012
800	1000	428010	458010	478010
	1200	428012	458012	478012
Usable height HU [U = 44.45 mm]		42 U	45 U	47 U
Frame height H [mm]		2000	2100	2200

SCOPE OF DELIVERY

Standard cabinet configuration:

- bolted frame,
- perforated single-leaf front door,
- perforated single-leaf or double-leaf rear door,
- top plate with ventilation perforation and knock-out blanking plates,
- two pairs of 19" mounting profiles, type PREMIUM,
- earthing conductors for doors, top plate and mounting profiles,
- levelling feet.

Accessories available separately:

- side panels and other Z-SERVER accessories,
- plinth, shelves, lighting kit, 19" blanking plates.

TECHNICAL DATA

Material

Sheet steel.

Protection degree

IP 20 in accordance with EN 60529 (does not apply to brush cable entries).

Surface finishing

Side panels, doors, top plate – powder paint, light grey (RAL 7035) or black (RAL 9005).

Mounting profiles and other metal parts – zinc-coated.



SERVER CABINETS **Z-SERVER 19"**

CONFIGURATOR

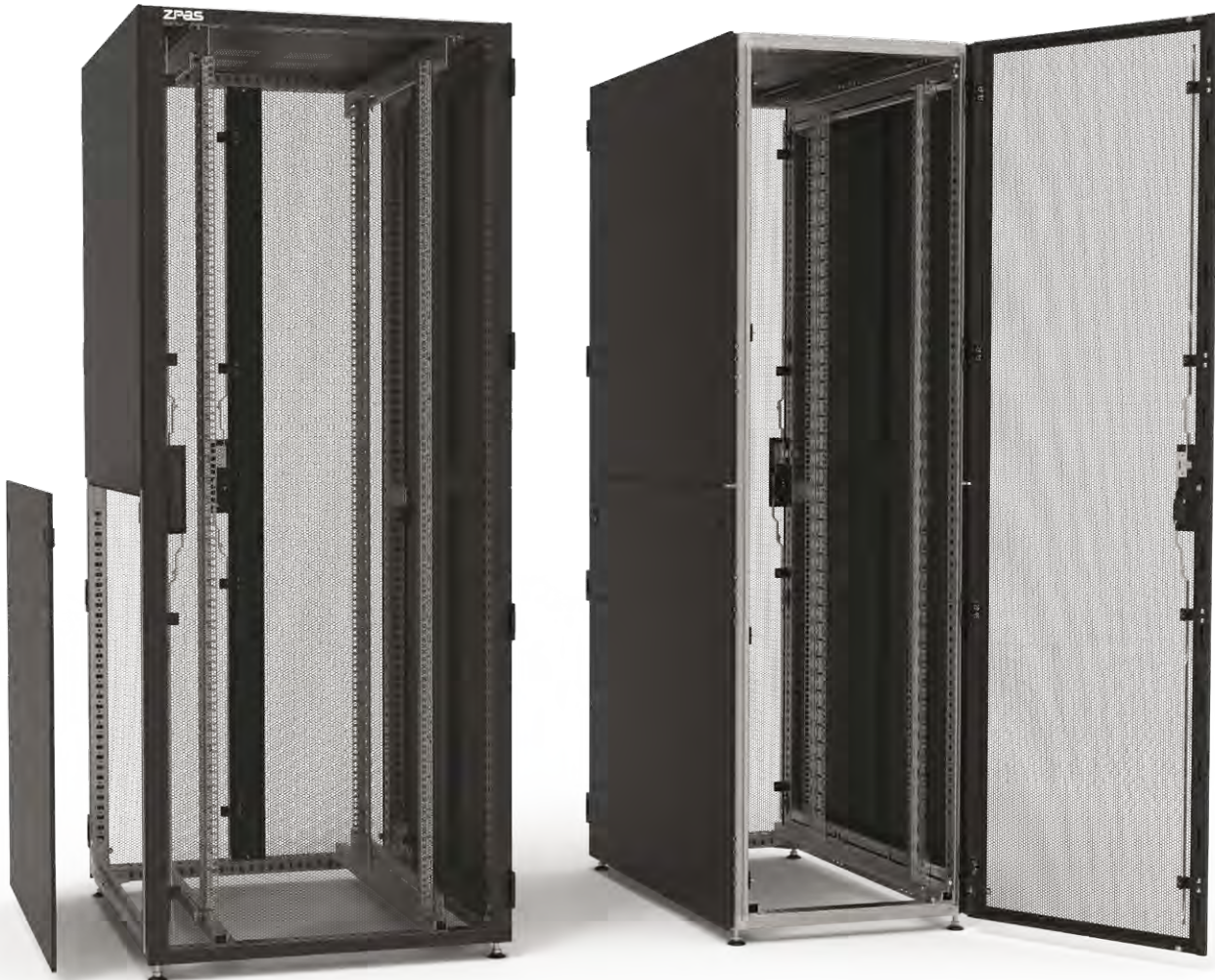

CATALOGUE NUMBER OF Z-SERVER CABINET

WZ-ZSERVER-XXXXXX-1X00-2-XXX

Reference number
specifies the cabinet's total dimensions (see reference chart).

Rear door type:
1 - perforated single-leaf door
2 - perforated double-leaf door

Cabinet's colour:
011 - RAL 7035 (light grey) 161 - RAL 9005 (black)

Z-SERVER 19" SERVER CABINETS

DESIGN

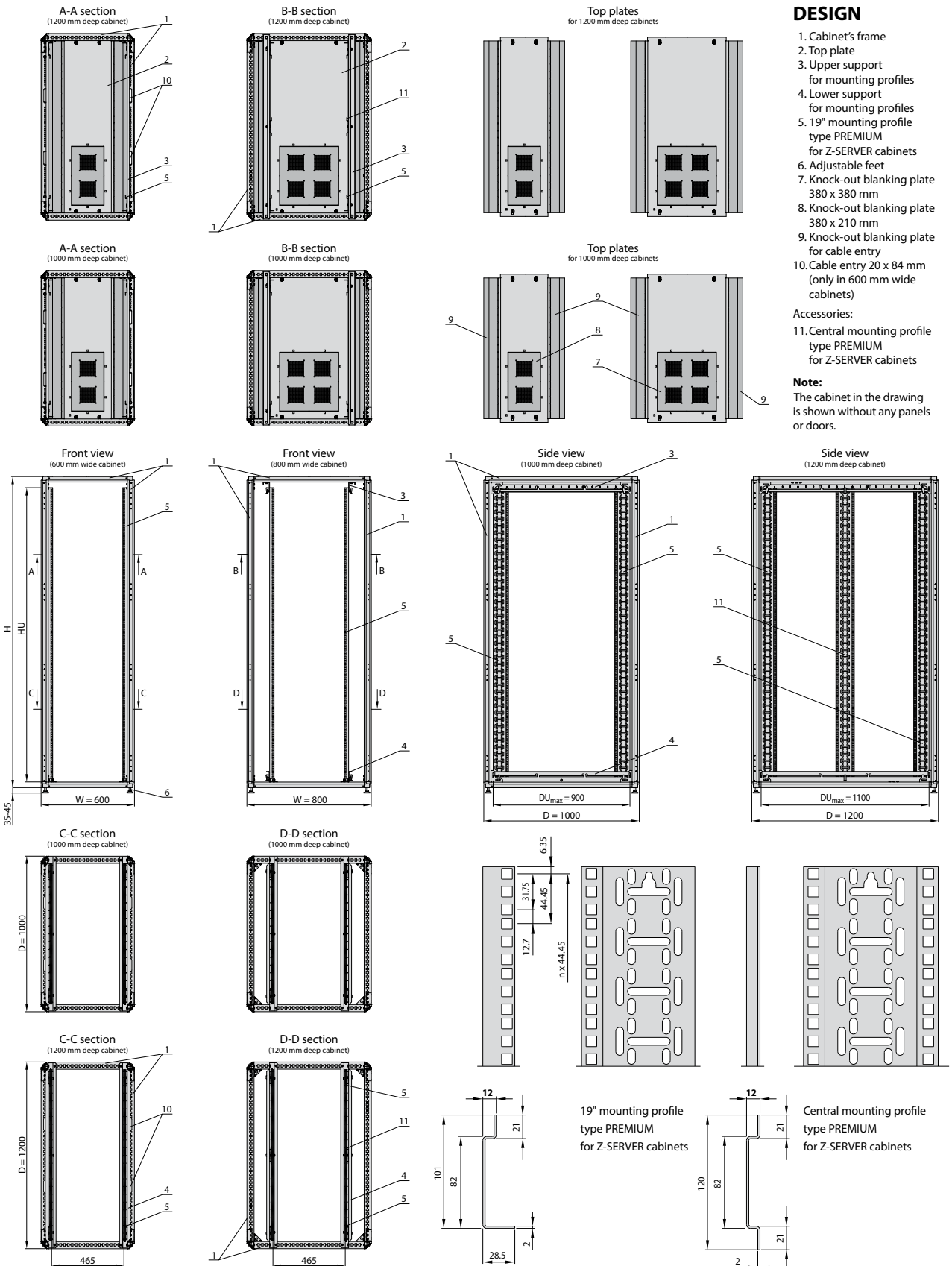

SERVER CABINETS **Z-SERVER 19"**

ACCESSORIES

Split side panels

Available in two types differing in depth.

Side panels type **A (shallow)**:

- allow to open the door up to 270 degrees;
- increase the cabinet width by 3 mm on each side.

Side panels type **B (deep)**:

- provides sufficient mounting space in 600 mm wide cabinets; enables the installation of a power strip between the side panel and the 19" mounting profile;
- increase the cabinet width by 11 mm on each side.

For cabinets'		Side panels type	Catalogue number	
height	depth		RAL 7035	RAL 9005
42 U	1000	A	WZ-8477-08-01-011	WZ-8477-08-01-161
		B	WZ-8477-09-01-011	WZ-8477-09-01-161
	1200	A	WZ-8477-08-02-011	WZ-8477-08-02-161
		B	WZ-8477-09-02-011	WZ-8477-09-02-161
45 U	1000	A	WZ-8477-08-03-011	WZ-8477-08-03-161
		B	WZ-8477-09-03-011	WZ-8477-09-03-161
	1200	A	WZ-8477-08-04-011	WZ-8477-08-04-161
		B	WZ-8477-09-04-011	WZ-8477-09-04-161
47 U	1000	A	WZ-8477-08-05-011	WZ-8477-08-05-161
		B	WZ-8477-09-05-011	WZ-8477-09-05-161
	1200	A	WZ-8477-08-06-011	WZ-8477-08-06-161
		B	WZ-8477-09-06-011	WZ-8477-09-06-161

Package: 1 set (1 split side panel)

Material

Sheet steel powder painted in light grey (RAL 7035) or black (RAL 9005).

Scope of delivery

Side panel split horizontally, consisting of upper and lower part, together with fixing accessories. The lower part is equipped with two sliding locks.



Partition panel

Designed for mounting between bayed cabinets.

It contains four 150 x 45 mm cable entries closed with knock-out blanking plates and four cut-outs for cabinet frame connectors. The front and bottom edges of the partition panel, bent at an angle of 90 degrees, facilitate its installation between the frames of adjacent cabinets. The distance between the cabinets needed to install the partition panel is only 2 mm.

The partition panel is available in two types differing in height:

- partition panel type **A for cabinets with feet**;
- partition panel type **B for cabinets without feet**.

For cabinets'		Partition panel type	Catalogue number	
height	depth		RAL 7035	RAL 9005
42 U	1000	A	WZ-8477-35-01-011	WZ-8477-35-01-161
		B	WZ-8477-35-07-011	WZ-8477-35-07-161
	1200	A	WZ-8477-35-02-011	WZ-8477-35-02-161
		B	WZ-8477-35-08-011	WZ-8477-35-08-161
45 U	1000	A	WZ-8477-35-03-011	WZ-8477-35-03-161
		B	WZ-8477-35-09-011	WZ-8477-35-09-161
	1200	A	WZ-8477-35-04-011	WZ-8477-35-04-161
		B	WZ-8477-35-10-011	WZ-8477-35-10-161
47 U	1000	A	WZ-8477-35-05-011	WZ-8477-35-05-161
		B	WZ-8477-35-11-011	WZ-8477-35-11-161
	1200	A	WZ-8477-35-06-011	WZ-8477-35-06-161
		B	WZ-8477-35-12-011	WZ-8477-35-12-161

Package: 1 pc.

Material

Sheet steel powder painted in light grey (RAL 7035) or black (RAL 9005).

Scope of delivery

Partition panel with fixing accessories.

Note: Cabinet frame connectors are ordered separately - see page 19.



Z-SERVER 19" SERVER CABINETS

ACCESSORIES

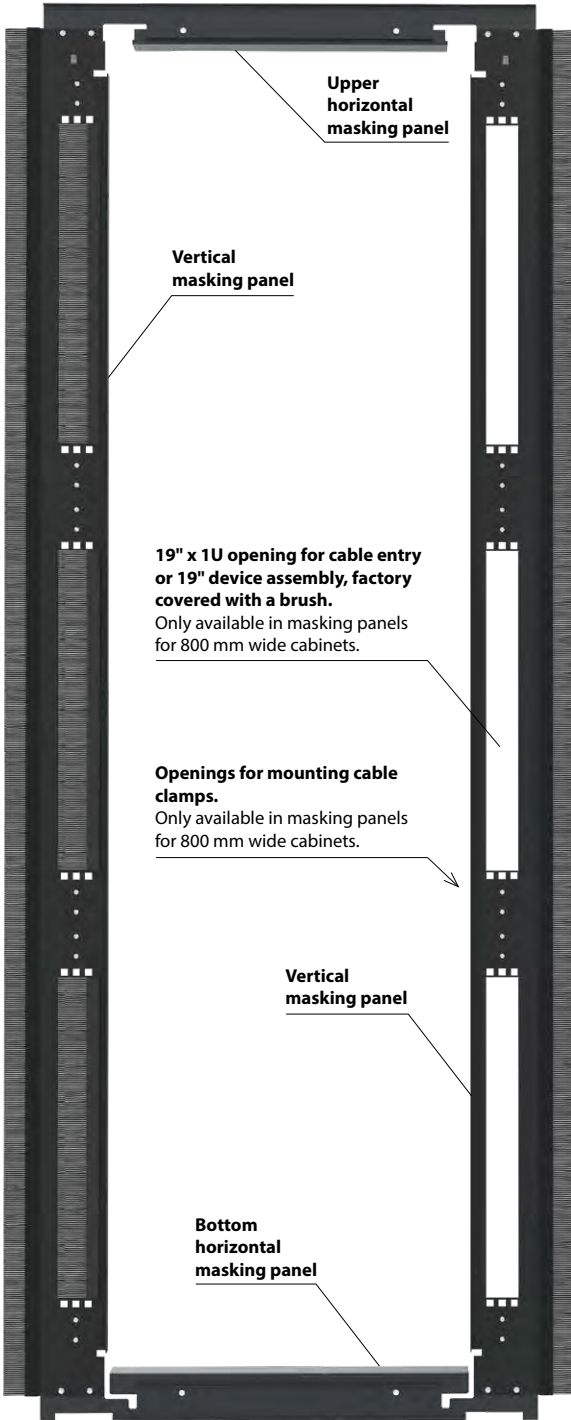

Vertical and horizontal masking panels for 800 mm wide cabinets

Vertical masking panels

For sealing the area between the 19" space and the cabinet side panel. The panels prevent the recirculation of hot air to the front area of the cabinet, and increase the efficiency of air conditioning systems.

In case of 800 mm wide cabinets the panels include openings for cable clamps mounting and 19" x 1U brush cable entries, to which, if necessary, 19" equipment can be installed instead of brush.

Vertical masking panels are mounted on 19" mounting profiles without the use of tool.

Material

Sheet steel powder painted in light grey (RAL 7035) or black (RAL 9005).

Scope of delivery

Set of two vertical masking panels with fixing accessories.

For cabinets'		Catalogue number	
height	width	RAL 7035	RAL 9005
42 U	600	WZ-8477-36-01-011	WZ-8477-36-01-161
	800	WZ-8749-E1-01-011	WZ-8749-E1-01-161
45 U	600	WZ-8477-36-02-011	WZ-8477-36-02-161
	800	WZ-8749-E1-02-011	WZ-8749-E1-02-161
47 U	600	WZ-8477-36-03-011	WZ-8477-36-03-161
	800	WZ-8749-E1-03-011	WZ-8749-E1-03-161

Package: 1 set (right and left masking panels)

Horizontal masking panels

For sealing the area between the 19" space and the top and bottom plate of the cabine. The panels prevent the recirculation of hot air to the front area of the cabinet, and increase the efficiency of air conditioning systems.

Horizontal masking panels are attached to the vertical masking panels.

Material

Sheet steel powder painted in light grey (RAL 7035) or black (RAL 9005).

Scope of delivery

Set of two horizontal masking panels with fixing accessories.

For cabinets'		Catalogue number	
height	width	RAL 7035	RAL 9005
42 U	600	WZ-8477-37-01-011	WZ-8477-37-01-161
	800	WZ-8749-E3-01-011	WZ-8749-E3-01-161
45 U	600	WZ-8477-37-02-011	WZ-8477-37-02-161
	800	WZ-8749-E3-02-011	WZ-8749-E3-02-161
47 U	600	WZ-8477-37-03-011	WZ-8477-37-03-161
	800	WZ-8749-E3-03-011	WZ-8749-E3-03-161

Package: 1 set (upper and lower masking panels)

SERVER CABINETS **Z-SERVER 19"**

ACCESSORIES

Brush strip for the top plate

Brush strip for attachment to a lateral edge of the upper plate after removing the knock-out blanking plate (see drawings of the top plates on page 12).

Material
Black plastic.

Scope of delivery
Brush strip.

For cabinets' depth	Catalogue number
1000	WZ-8477-57-01-000
1200	WZ-8477-57-02-000

Package: 1 pc.



Z-SERVER cabinet top plate 800 x 1200 mm with brush strips

Bottom plate and side brush strips

Available in a few sizes suitable for width and depth of the cabinet.
Side brush strips are designed only for cabinet 800 mm wide.

Material
Sheet steel powder painted in light grey (RAL 7035) or black (RAL 9005), black plastic.

Scope of delivery
Depending on chosen version: plate with brush cable entry, solid steel plate, plate with knock-out cable entry, side brush strips.

type	For cabinets'		Catalogue number	
	width	depth	RAL 7035	RAL 9005
Cabinet without castors set	600	1000	WZ-8477-D7-01-011	WZ-8477-D7-01-161
	800	1000	WZ-8477-D7-02-011	WZ-8477-D7-02-161
	600	1200	WZ-8477-D7-03-011	WZ-8477-D7-03-161
	800	1200	WZ-8477-D7-04-011	WZ-8477-D7-04-161
Cabinet with castors set	600	1000	WZ-8477-D7-05-011	WZ-8477-D7-05-161
	800	1000	WZ-8477-D7-06-011	WZ-8477-D7-06-161
	600	1200	WZ-8477-D7-07-011	WZ-8477-D7-07-161
	800	1200	WZ-8477-D7-08-011	WZ-8477-D7-08-161

Package: 1 set



WZ-8477-D7-03-161



WZ-8477-D7-08-161

Z-SERVER 19"

SERVER CABINETS

ACCESSORIES



WZ-8477-73-02-161
Non-locking castors set



WZ-8477-74-02-161
Locking castors set

Castors set

Designed for Z-SERVER cabinets to increase their mobility. Maximum load capacity: 1500 kg.

Material

Sheet steel powder painted in light grey (RAL 7035) or black (RAL 9005), holders from zinc-coated steel, plastic castors.

Scope of delivery

Castors set with fixing accessories.

For cabinets' width	Castors type	Catalogue number	
		RAL 7035	RAL 9005
600	non-locking	WZ-8477-71-03-011	WZ-8477-71-03-161
	locking	WZ-8477-71-04-011	WZ-8477-71-04-161
800	non-locking	WZ-8477-73-02-011	WZ-8477-73-02-161
	locking	WZ-8477-74-02-011	WZ-8477-74-02-161

Package: 1 pc.



Sealing masking strip for cabinet on feet

Sealing masking strip protects from getting cold air from the aisle to the space under the cabinet.

Material

Sheet steel powder painted in light grey (RAL 7035) or black (RAL 9005), black plastic.

Scope of delivery

Sealing masking strip with fixing accessories.

For cabinets' width	Catalogue number	
	RAL 7035	RAL 9005
600	WZ-8477-D4-01-011	WZ-8477-D4-01-161
800	WZ-8477-D4-02-011	WZ-8477-D4-02-161

Package: 1 pc.



Cabinet equipped with castors sets, feet and sealing masking strip

SERVER CABINETS **Z-SERVER 19"**

ACCESSORIES

Vertical cable comb

For 600 mm and 800 mm wide cabinets. To arrange cabling in the vertical direction. Mounted on 19" mounting profile without the use of tool.

Material

Black plastic;
sheet steel powder paintet in light grey (RAL 7035) or black (RAL 9005).

Scope of delivery

Vertical cable comb with fixing accessories.

For cabinets' height	Catalogue number	
	RAL 7035	RAL 9005
42 U	WZ-8477-39-01-011	WZ-8477-39-01-161
45 U	WZ-8477-39-02-011	WZ-8477-39-02-161
47 U	WZ-8477-39-03-011	WZ-8477-39-03-161

Package: 1 pc.

Vertical cable tray with cover

For 800 mm wide cabinets. For arranging high-density cabling in the vertical direction. Mounted on a 19" mounting profile without the use of tools.

Material

Black plastic;
sheet steel powder painted light grey (RAL 7035) or black (RAL 9005).

Scope of delivery

Vertical cable tray with cover and fixing accessories.

For cabinets' height	Catalogue number	
	RAL 7035	RAL 9005
42 U	WZ-8477-38-01-011	WZ-8477-38-01-161
45 U	WZ-8477-38-02-011	WZ-8477-38-02-161
47 U	WZ-8477-38-03-011	WZ-8477-38-03-161

Package: 1 pc.

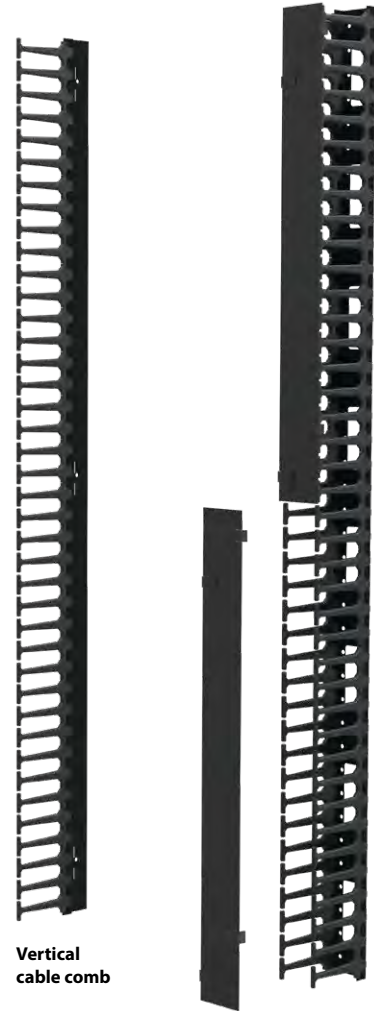

Vertical cable comb

Vertical cable tray with cover

19" cable trays

Mounted between 19" mounting profiles.
Available in 1 U and 2 U heights.

Material

Black plastic.

Scope of delivery

Cable tray without fixing accessories.

Height	Catalogue number
1 U	T-SO-900-614
2 U	T-SO-900-615
1 U double	T-SO-900-618

Package: 1 pc.

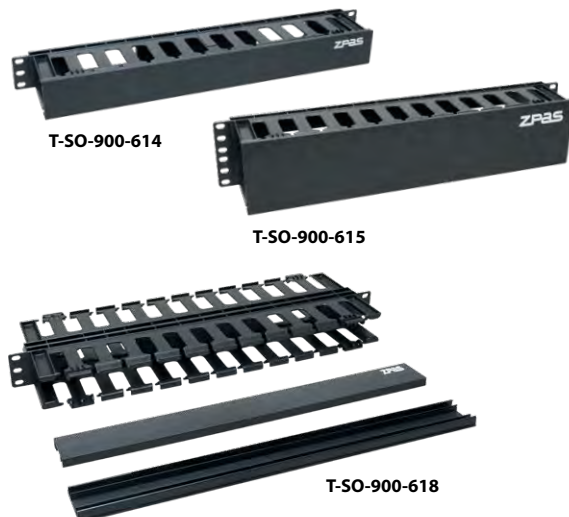

T-SO-900-614

T-SO-900-615

T-SO-900-618

Z-SERVER 19"

SERVER CABINETS

ACCESSORIES

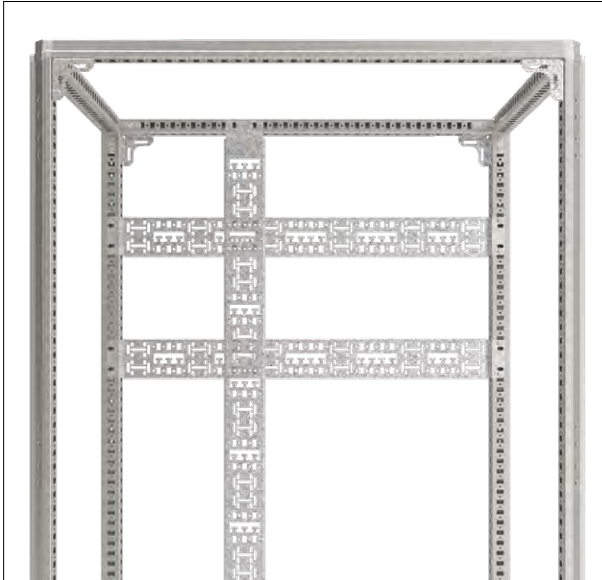

Vertical and horizontal organizers

Intended for:

- arrangement of logical cabling,
 - arrangement of power supply cables,
 - mounting of power distribution strips and other accessories.
- The organizers are mounted on the cabinet frame.

Material

Al-Zn coated sheet steel.

Scope of delivery

Vertical or horizontal organizer with fixing accessories.

Vertical organizer

For cabinets'		Catalogue number
width	height	
800	42 U	WZ-8477-40-01-000
	45 U	WZ-8477-40-02-000
	47 U	WZ-8477-40-03-000

Package: 1 pc.

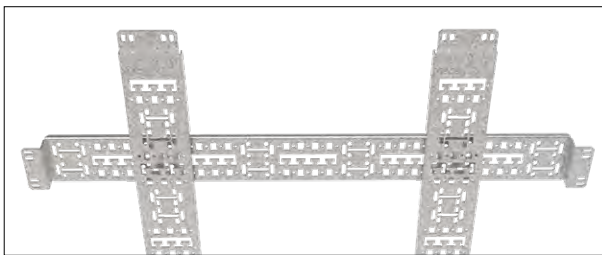

Horizontal organizer

For cabinets'		Catalogue number
width	depth	
600 or 800	1000	WZ-8477-41-01-000
	1200	WZ-8477-41-02-000

Package: 1 pc.

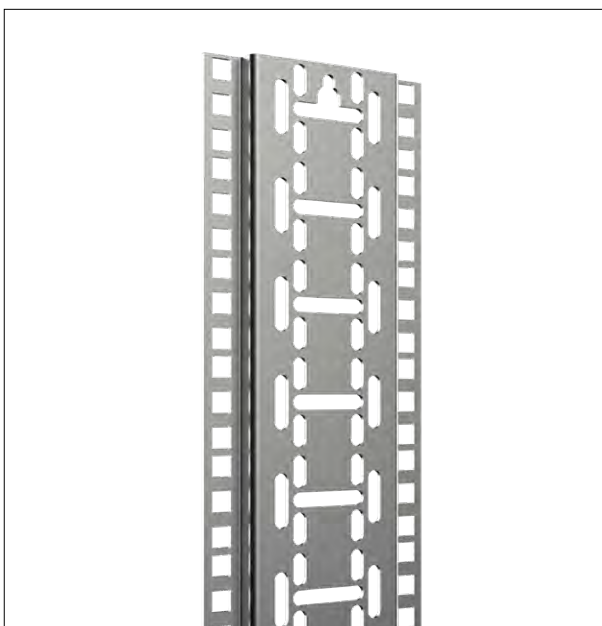

Central mounting profile type PREMIUM for Z-SERVER cabinets

Mounted to the upper and lower support of mounting profiles without the use of tool (see drawing on page 12).

Material

Al-Zn coated sheet steel.

Scope of delivery

Central mounting profile with fixing accessories.

Height	Catalogue number
42 U	WZ-8477-49-01-000
45 U	WZ-8477-49-02-000
47 U	WZ-8477-49-03-000

Package: 1 pc.

SERVER CABINETS **Z-SERVER 19"**

ACCESSORIES

Adapting set for double-leaf door

Designed for changing locking system in Z-SERVER double-leaf door cabinet from 3-point to 5-point locking system.

Material

Zinc-coated steel, black plastic.

Scope of delivery

Lock cam, handle with gear, two rod-latches, plastic holders and fixing accessories.

For cabinets' height	Catalogue number
42 U	WZ-8477-91-01-000
45 U	WZ-8477-91-02-000
47 U	WZ-8477-91-03-000



Adapting set to double-leaf door

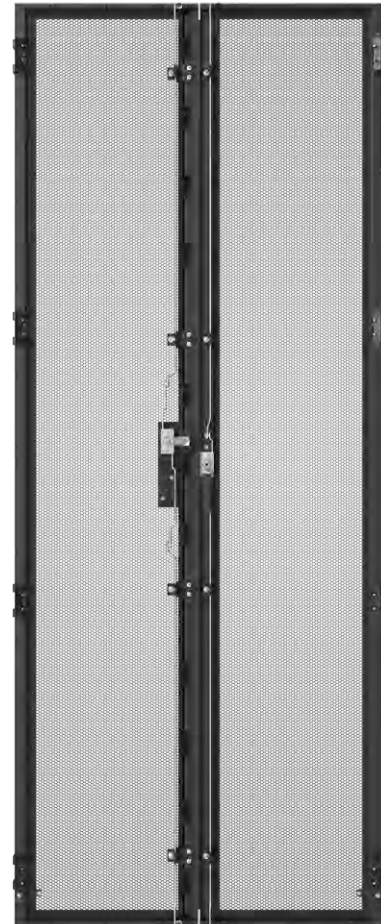

Double-leaf door with adapting set

Cabinet connection set

For buying Z-SERVER cabinets in row.
One set is intended for buying two cabinets.

Material

Al-Zn coated sheet steel.

Scope of delivery

Set: 4 external cabinet frame connectors with fixing accessories.

Package	Catalogue number
1 set	WZ-8390-24-00-000/KPL



External cabinet frame connector



Z-SERVER 19" SERVER CABINETS

COLD AISLE INSTALLATIONS

Cold aisle installation

The **Z-SERVER BOX** solution physically separates the air distributed by air conditioners and the hot air generated by operating equipment.

Z-SERVER BOX optimises the usability of the data centre infrastructure.

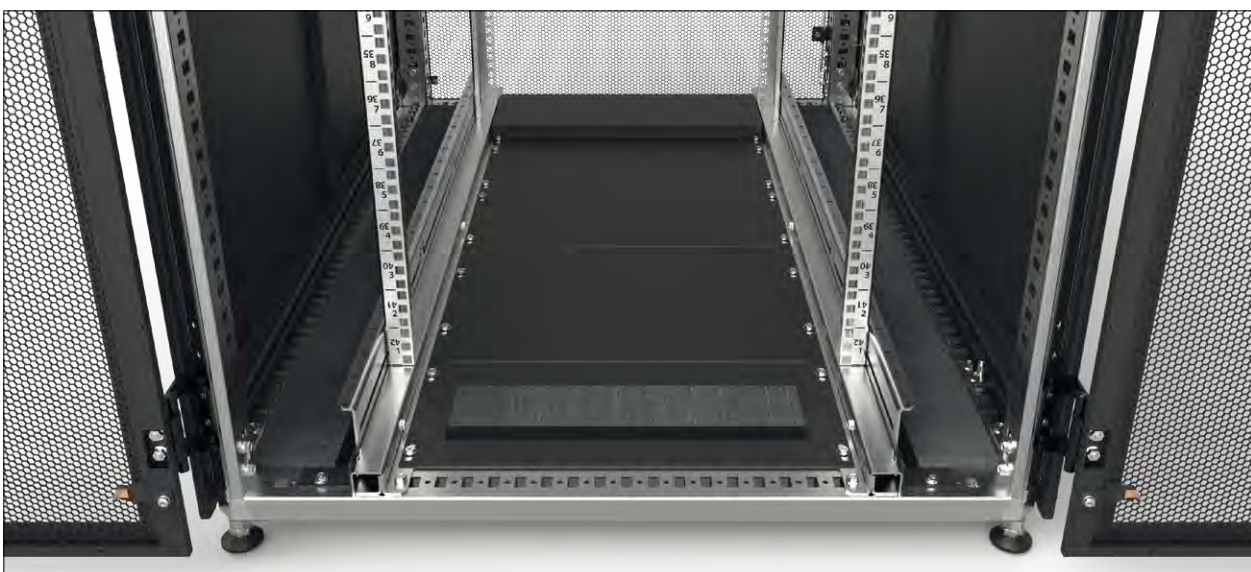

SERVER CABINETS **Z-SERVER 19"**

COLD AISLE INSTALLATIONS

Cold aisle sliding door

Manual sliding glass doors without a lock. Opened along the entire width of the aisle. Supplied with a roof masking panel and cabinet side panels.
Designed for cold aisle **1200 mm** wide.

Material

Aluminium profiles; safety glass; sheet steel powder painted in light grey (RAL 7035) or black (RAL 9005).

Scope of delivery

Two sliding door leaves with rails, runners and self-closer, two cabinet side panels, aisle roof masking panel, fixing accessories.

Automatic doors are also available.



For Data Box cabinets¹		Catalogue number	
height	depth	RAL 7035	RAL 9005
42 U without feet	1000	WZ-8477-42-02-011	WZ-8477-42-02-161
	1200	WZ-8477-42-06-011	WZ-8477-42-06-161
45 U without feet	1000	WZ-8477-42-10-011	WZ-8477-42-10-161
	1200	WZ-8477-42-14-011	WZ-8477-42-14-161
47 U without feet	1000	WZ-8477-42-18-011	WZ-8477-42-18-161
	1200	WZ-8477-42-22-011	WZ-8477-42-22-161
42 U with feet	1000	WZ-8477-42-04-011	WZ-8477-42-04-161
	1200	WZ-8477-42-08-011	WZ-8477-42-08-161
45 U with feet	1000	WZ-8477-42-12-011	WZ-8477-42-12-161
	1200	WZ-8477-42-16-011	WZ-8477-42-16-161
47 U with feet	1000	WZ-8477-42-20-011	WZ-8477-42-20-161
	1200	WZ-8477-42-24-011	WZ-8477-42-24-161

Package: 1 set.

Cold aisle raised roof

Roof module with internal height 150 mm, designed for cold aisle 1200 mm wide. The top transparent element of the module is tilt-mounted and can be installed without the use of tool. Modular design simplifies expansion.

Material

Transparent plastic (polycarbonate); sheet steel powder painted in light grey (RAL 7035) or black (RAL 9005).

Scope of delivery

Roof module with fixing accessories.

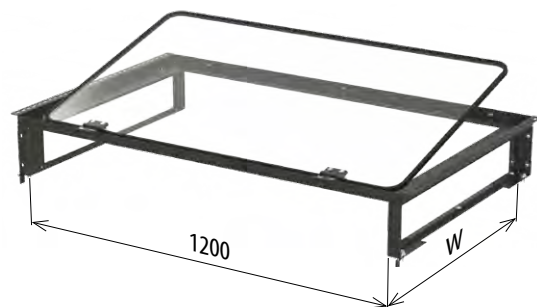

Module width W [mm]	Catalogue number	
	RAL 7035	RAL 9005
300	WZ-8744-C4-01-011	WZ-8744-C4-01-161
600	WZ-8477-C4-02-011	WZ-8477-C4-02-161
800	WZ-8477-C4-03-011	WZ-8477-C4-03-161

Package: 1 pc.

Z-SERVER 19" SERVER CABINETS

COLD AISLE INSTALLATIONS

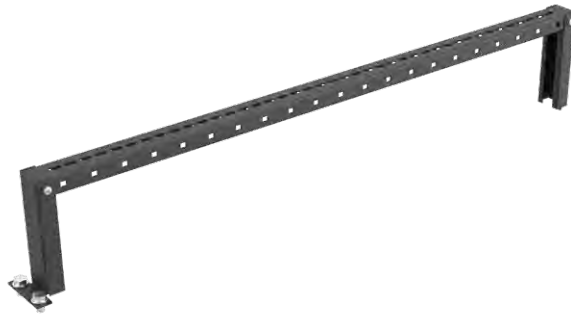

Cable tray bracket

Designed for cables organization on Z-SERVER cabinets roofs. It is mounted by depth on two cabinets buying in row. From one side it is bolted to back corners of the cabinet, from another it is set on frame.

Material

Sheet steel powder painted in light grey (RAL 7035) or black (RAL 9005).

Scope of delivery

Cable tray bracket with fixing accessories.

For cabinets' depth	Catalogue number	
	RAL 7035	RAL 9005
1000	WZ-8749-45-01-011	WZ-8749-45-01-161
1200	WZ-8749-45-02-011	WZ-8749-45-02-161

Package: 1 pc.



Side cable tray bracket

Designed for cables organization on Z-SERVER cabinets roofs. It is mounted on side cabinet. From one side it is bolted to cable tray bracket, from another it is set on frame.

Material

Sheet steel powder painted in light grey (RAL 7035) or black (RAL 9005).

Scope of delivery

Cable tray bracket with fixing accessories.

For cabinets' width	Catalogue number	
	RAL 7035	RAL 9005
600	WZ-8477-D6-01-011	WZ-8477-D6-01-161
800	WZ-8477-D6-02-011	WZ-8477-D6-02-161

Package: 1 pc.

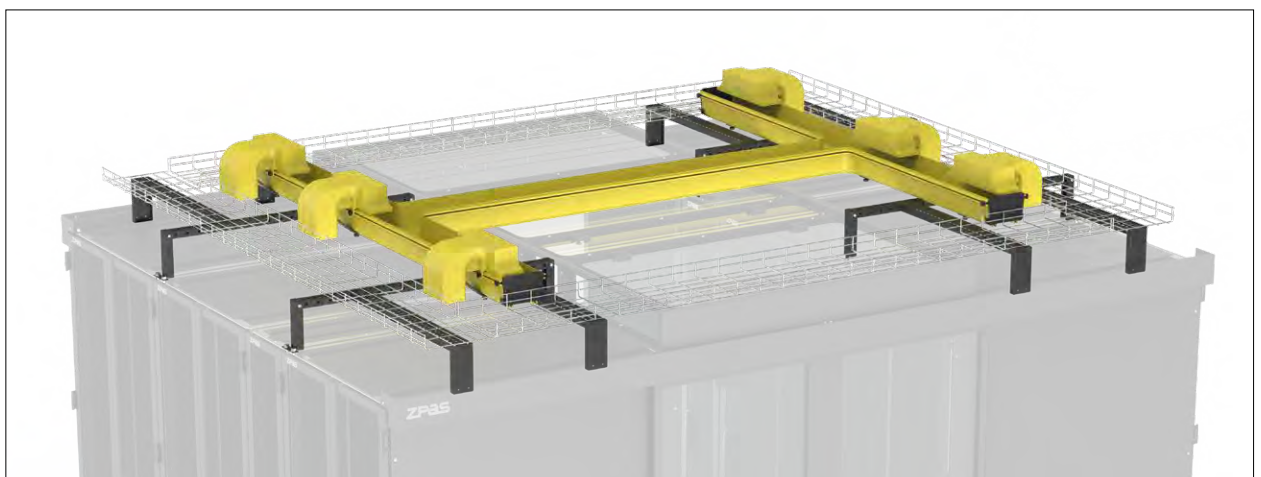

SERVER CABINETS **Z-SERVER 19"**

COLD AISLE INSTALLATIONS

Aisle lightening

Light fitting is for assembling under the aisle roof.
Dimensions: 26,2 x 24,5 mm. The length shall be chosen by 200 mm less than the width of the aisle.

Material

Aluminium body silver or black, frosted plexiglass.

Scope of delivery

Electric light fitting with 12 V LEDs, power supply cable without plug, fixing accessories.
Power supply and control components are ordered separately.



Product name	Catalogue number	
	Silver	Black
Light fittings		
Light fitting, 1000 mm long	WN-8477-Z1-02-011	WN-8477-Z1-02-161
Power supply components	RAL 7035	RAL 9005
Main PS-3U 19" panel with powering elements for light fittings	WN-8477-Z1-04-011	WN-8477-Z1-04-161
Additional PS-3U 19" panel with powering elements for light fittings	WN-8477-Z1-05-011	WN-8477-Z1-05-161
Bracket for assembling PS-3U 19" panel on Z-SERVER cabinet roof	WZ-8848-A5-01-011	WZ-8848-A5-01-161
Control components	White	Black
Microwave motion detector	WN-8477-Z1-06-011	WN-8477-Z1-06-161
Touch light switch (one button)	---	WN-8477-Z1-07-000

Package: 1 pc.

Power strip brackets

Intended for vertical mounting power strips onto mounting profiles type PREMIUM.

Tool-free mounting.

Material

Zinc-coated sheet steel powder painted in light grey (RAL 7035) or black (RAL 9005).

Scope of delivery

Bottom and top bracket with fixing accessories.

Product name	Catalogue number	
	RAL 7035	RAL 9005
Set of brackets for mounting two power strips	WZ-8626-83-00-011-KPL	WZ-8626-83-00-161-KPL
Set of brackets for mounting one power strip	WZ-8626-83-01-011-KPL	WZ-8626-83-01-161-KPL

Package: 1 set



WZ-8626-83-00-161-KPL

WZ-8626-83-01-161-KPL